

MAIN FEATURES

- 90 – 264 V_{AC} Universal input voltage range
- 400 W rated power (440 W peak)
- Extremely high efficiency (94% typical)
- Low stand-by consumption (<0.5 W)
- 12, 24, 28, 36 or 48V standard output variants
- Active PFC, EN61000-3-2 compliant (Class C)
- Low earth leakage current
- Fan speed control circuit (off at <50 W load)
- Over temperature protection
- OV, OC, and short circuit protections
- +5 V Stand-by, 2 A output
- 12 V Auxiliary, 1 A output
- Remote On/Off and power good signals
- U-chassis and boxed packages fit 1U applications.
- ANSI/AAMI ES60601-1 3rd ed. compliant
IEC/EN 60601-1 3rd ed. compliant
- RoHS 3 compliant (EU directive 2015/863)
- 4000 m altitude operation

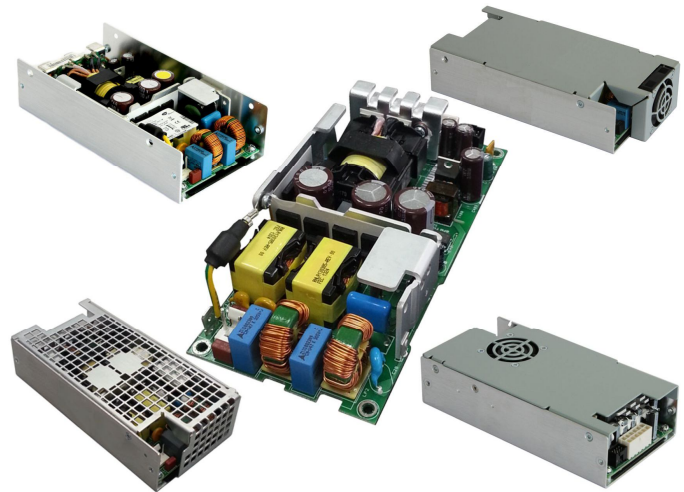

DESCRIPTION

The MDP400 series of medical AC-DC power supplies feature a compact form factor, high conversion efficiency and 2x MoPP means of protection grade.

The series provides a steady 400 W of regulated DC power through the full 90 to 264 V_{AC} input voltage range. Based on an open frame, 3.00" x 6.50" x 1.46" form factor, the series is available in five different low-profile packages to enable designers to integrate into 1U applications.

By converting energy at 94% typical efficiency, the MDP400 series generates less heat facilitating thermal management in space constrained systems and offering high reliability.

The MDP series is available in five standard output voltages: 12, 24, 28, 36, 48 V_{DC}, offer an auxiliary 12 V_{DC} and 5 V_{DC} stand-by outputs. Available control signals include Power Good (P_OK), Remote On/Off (PS_ON) and (+) remote sense compensation.

Boxed and vented open frame models can deliver full output power up to 50 °C, can operate up to 70 °C with de-rating and are capable of start up from –30 °C.

A built-in fan speed control circuit in the boxed packages assures proper forced air cooling, minimizing operational noise and enhancing useful life time.

The MDP400 series complies with the 3rd edition of the IEC 60601-1 safety standard for medical equipment, offers 2xMoPP means of patient protection and is suitable for BF rated applied parts.

The MDP400 series meets the EN 60601-1-2 EMC limits of Class B for conducted and radiated emissions as well as the IEC/EN61000-3, for harmonic and flicker, and IEC/EN 60601-1-2 4th edition for EMC immunity standards.

MARKET SEGMENTS AND APPLICATIONS

- Diagnostic equipment
- Imaging equipment
- Respiratory devices
- Therapy appliances
- Dental equipment
- Dermatology aesthetic medicine

MODEL CODING AND OUTPUT RATINGS

Model and Output Power	Output Nominal Voltage	Package Option	Means of Protection Grade
Medical 400W: MDP400-	12 V _{DC} : -US12	Open Frame: -OF	2xMoPP: -PP
	24 V _{DC} : -US24	U-Chassis: -UC	
	28 V _{DC} : -US28	Punched Cover: -PC	
	36 V _{DC} : -US36	Vented Cover: -VC	
	48 V _{DC} : -US48	Front Fan: -FF	

MODEL CODING AND OUTPUT RATINGS

Model Number	V1 [V]	I1 ¹ Convection [A]	I1 ² Forced air [A]	V1 ³ Ripple [mV]	V2 [V]	I2 ¹ Rated [A]	V2 ³ Ripple [mV]	5V _{SB} [V]	I5V _{SB} ¹ Convection [A]	I5V _{SB} ² Forced air [A]	5V _{SB} ³ Ripple [mV]
MDP400-US12-OF/UC/PC-PP	12	20.8	33.3	120	12	1	240	5	1.5	2	50
MDP400-US24-OF/UC/PC-PP	24	10.4	16.7	240	12	1	240	5	1.5	2	50
MDP400-US36-OF/UC/PC-PP	36	6.9	11.1	360	12	1	240	5	1.5	2	50
MDP400-US48-OF/UC/PC-PP	48	5.2	8.3	480	12	1	240	5	1.5	2	50
MDP400-US12-VC/FF-PP	12	-	33.3	120	12	1	240	5	-	2	50
MDP400-US24-VC/FF-PP	24	-	16.7	240	12	1	240	5	-	2	50
MDP400-US36-VC/FF-PP	36	-	11.1	360	12	1	240	5	-	2	50
MDP400-US48-VC/FF-PP	48	-	8.3	480	12	1	240	5	-	2	50
MDP400-US28-UC-PP	28	8.9	14.3	280	12	1	240	5	1.5	2	50

¹ The combined output power of V1, V2 and 5V_{SB} for "-OF", "-UC" and "-PC" packages, must not exceed 400 W when cooled by 400 LFM air flow, and 250 W when natural convection cooled, up to 50 °C. Above 50 °C output de-rating applies. See de-rating curves below.
In any case, the heat sink maximum temperature should not exceed +110 °C at 50 °C ambient temperature.

² The combined output power of V1, V2 and 5 V_{SB} for "-VC" and "-FF" packages, must not exceed 400 W up to 50 °C, and 280 W at 70 °C ambient temperature. See de-rating curves below.

³ Peak-to-Peak measured at 20 MHz Bandwidth.

INPUT SPECIFICATIONS

Specification	Test Conditions / Notes	Min.	Nominal	Max.	Units
AC Input Voltage	PS starts and operates at 90 V _{AC} at all load conditions	90	100-240	264	V _{AC}
DC Input Voltage		170	-	270	V _{DC}
Input Frequency		47	50/60	440	Hz
Input Current	RMS at 180 V _{AC} , maximum load RMS at 90 V _{AC} , maximum load	-	-	2.5 5	A
Inrush Current (peak)	265 V _{AC} , 25 °C ambient, cold start. 24, 28, 36, 48 V (no damage) 12 V	-	-	100 20	A
Fusing	2X Time Lag 6.3 A, 250 V on both L and N	-	-	6.3	A
Efficiency	At 230 V _{AC} : 20% rated load 50 – 100 % rated load At 115 V _{AC} : 20% rated load 50 – 100 % rated load	-	90 94 90 92	-	%
Input Power Consumption	Power on, 115-230 V _{RMS} , no load Stand by, 115-230 V _{RMS} , no load	-	1 0.4	1.5 0.5	W
Power Factor	At full rated load, 115 V _{AC} , 60 Hz and 230 V _{AC} , 50 Hz input voltages	0.95	-	-	-
Harmonic Current	Complies with EN-61000-3-2 Class C at 230 V _{AC} 50 Hz, load >50 W.				
Fluctuations and Flicker	Complies with EN-61000-3-3 at nominal voltages and full load.				
Leakage Current	Normal conditions, 240 V _{RMS} , 60 Hz.	-	-	300	µA

OUTPUT SPECIFICATIONS

Specification	Test Conditions / Notes	Min.	Nom.	Max.	Units
V1 Output Voltage	0.5% set point accuracy for all voltage variants	-	12	-	V
		-	24	-	
		-	28	-	
		-	36	-	
		-	48	-	
V1 Output Power Rating	All voltages, OF/UC/PC, convection cooling	-	-	250	W
	All voltages, VC/FF, and OF/UC/PC forced air cooling (> 400 LFM)	-	-	400	
	All models, peak power (≤ 10 s)	-	-	440	
V2 Output Voltage ⁴	All models. Load on V2: from 5 to 1000 mA Load on V1: from 0.1 to I1 rated	11.35	11.5	12.65	V
V2 Output Current (I2)	Convection / forced air cooling	-	-	1	A
5V_{SB} Output Voltage	3% set point accuracy	-	5	-	V
5V_{SB} Output Current (I5V_{SB})	OF/UC/PC, natural convection cooling	-	-	1.5	A
	VC/FF, OF/UC/PC forced air cooling (> 400 LFM)	-	-	2	
V1 Voltage Adjustment Range		-	-	±5	%V1
V1 Load-Line-Cross Regulation	V _{AC} : 90 – 264 V _{RMS}	-	-	±2	%V1
	V1 Load: 0 – 33.3 A (12 V _{DC})				
	0 – 16.7 A (24 V _{DC})				
	0 – 14.3 A (28 V _{DC})				
	0 – 13.9 A (36 V _{DC})				
	0 – 8.3 A (48 V _{DC})				
V2 Load: 0 – 1 A					
5 V _{SB} Load: 0 – 2 A					
5V_{SB} Load-Line-Cross regulation	V _{AC} : 90 – 264 V _{RMS}	-	-	±5	%5V _{SB}
	V1 Load: 0 – 33.3 A (12 V _{DC})				
	0 – 16.7 A (24 V _{DC})				
	0 – 14.3 A (28 V _{DC})				
	0 – 13.9 A (36 V _{DC})				
	0 – 8.3 A (48 V _{DC})				
V2 Load: 0 – 1 A					
5 V _{SB} Load: 0 – 2 A					
V1 Line Regulation	V _{AC} : 90 – 264 V _{RMS}	-	-	±0.1	%V1
Transient Response (Voltage Deviation) V1, 5V_{SB}	25% load changes at 1 A/μs	-	-	±5	%V1 %5V _{SB}
	12 V _{DC} at 2200 μF Load / I _{OUT} > 0.5 A				
	24 V _{DC} at 1000 μF Load / I _{OUT} > 0.5 A				
	28 V _{DC} at 1000 μF Load / I _{OUT} > 0.5 A				
	36 V _{DC} at 820 μF Load / I _{OUT} > 0.5 A				
	48 V _{DC} at 560 μF Load / I _{OUT} > 0.5 A				
5 V _{SB} at 560 μF Load / I _{OUT} > 0.1 A					
V1 Ripple and Noise	All models, Peak-to-peak, 20 MHz BW. 100 nF ceramic and 10 μF tantalum caps at the load.	-	-	1	%V1
Start-up Rise Time	90 < V _{IN} < 264, any load conditions.	5	-	85	ms
Start-up Delay	V1 in regulation after PS_ON is asserted	-	-	200	ms
	V1 in regulation after AC is applied	-	-	750	
Turn-on Overshoot	5V _{SB} in regulation after AC is applied	-	-	500	%V1 %V2 %V _{SB}
	At I1 = 500 mA, V1 in regulation within 50 ms	-	10	-	
		-	10	-	
Hold-up Time	At nominal V _{IN} , 400 W, for all models	-	16	-	ms
	At nominal V _{IN} , 365 W, for all models	-	20	-	
	At nominal V _{IN} , 200 W, for all models	-	35	-	
Minimum Load ⁴	All models; V1, V2 and 5V _{SB}	0	-	-	A
Maximum Load Capacitance	At nominal V _{IN} , 25 °C ambient	-	-	33000	μF
	12 V _{DC}	-	-	16000	
	24 V _{DC}	-	-	14300	
	28 V _{DC}	-	-	10000	
	36 V _{DC}	-	-	7000	
48 V _{DC}	-	-	7000		
Temperature Drift		-1.2	-	+1.2	mV/°C

⁴ When the load on the main output is less than 100 mA, V2 output voltage might regulate below its minimum value. Contact ENEDO for details.

SIGNALS / CONTROLS

Signal	Notes	Min	Typ	Max	Unit
PS_ON	Active low, +5 V TTL signal compatible. Input low voltage	0	-	2.0	V
	Input high voltage ($I_{IN} = 200 \mu A$)	3.0	-	-	V
	V1 and V2 disabled when PS_ON is open				
	5V _{SB} not affected by PS_ON				
P_OK	V1 and V2 enabled with PS_ON connected to RTN				
	+5 V TTL compatible				
	Logic level low (<10 mA sinking)	-	-	0.7	V
	Logic level high (100 μA sourcing)	2.4	-	5	V
5V_{SB} output	Low to high time after V1 in regulation	0.05	-	0.1	s
	Power down warning time	1	-	-	ms
	Active and in regulation after a $90 < V_{AC} < 264$ is applied	-	-	200	ms
	5V _{SB} not affected by PS_ON				

SIGNALS TIMING

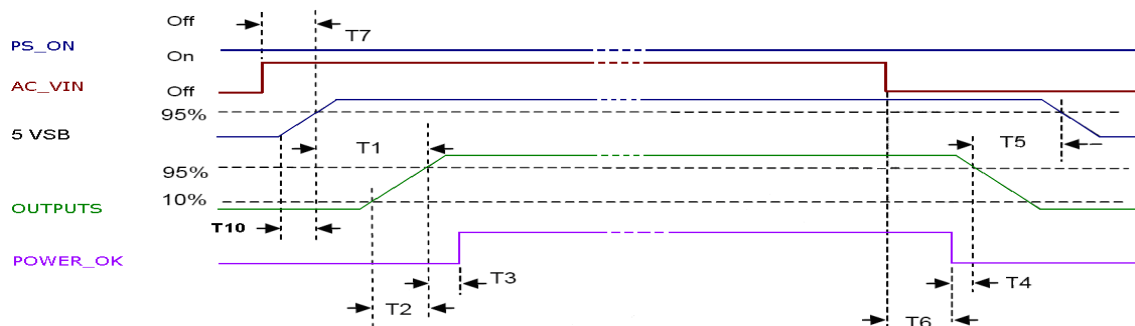

Above waveforms are expected with AC Input ON/OFF:

Standby on - Main outputs on	$50 \text{ ms} \leq T1 \leq 250 \text{ ms}$
Main output Rise Time	$5 \text{ ms} \leq T2 \leq 85 \text{ ms}$
5 VSB Rise Time	$4 \text{ ms} \leq T10 \leq 20 \text{ ms}$
Main outputs On – P_OK delay	$40 \text{ ms} \leq T3 \leq 100 \text{ ms}$
Power down warning ⁵	$T4 \geq 1 \text{ ms}$
Main Output off – Standby off ⁶	$T5 \geq 1.2 \text{ s}$
Hold-up time (AC off – P_OK low)	$T6 \geq 15 \text{ ms (115/ 230 V}_{AC})$
AC_ON - Standby turn on time	$T7 \leq 500 \text{ ms}$

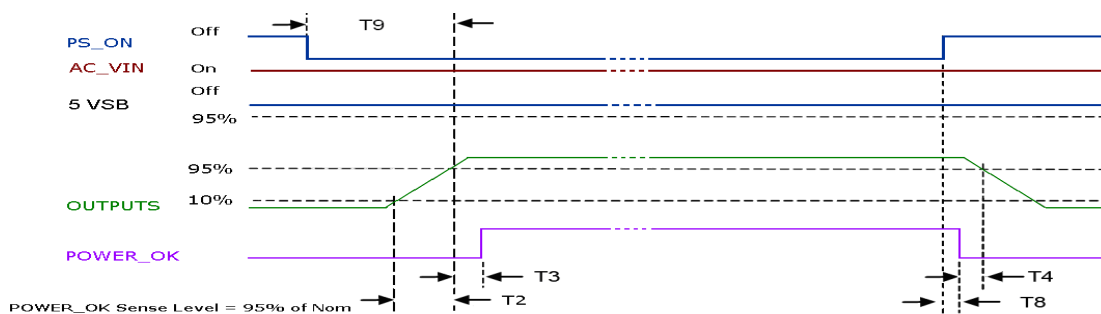

Above waveforms are expected with PS_ON Signal ON/OFF state change:

Main Output Rise Time	$5 \text{ ms} \leq T2 \leq 85 \text{ ms}$
Main Outputs on – P_OK delay	$50 \text{ ms} \leq T3 \leq 100 \text{ ms}$
Power down warning ¹	$1 \text{ ms} \leq T4 \leq 5 \text{ ms}$
PS_ON - Main Output (off) Timing	$T8 \leq 1 \text{ ms}$
PS_ON - Main Output (on) Timing	$T9 \leq 200 \text{ ms}$

⁵ T4 parameter measurement setup will assume at least 10% of the maximum load on each output.

⁶ T5 parameter measurement setup will assume at least 50% of the maximum load on main output.

PROTECTION FEATURES

Specification	Test Conditions / Notes	Min.	Nominal	Max.	Units
Input Under Voltage Lockout	Auto recovery, Hiccup Mode	60	75	-	V _{AC}
Input Fuse	2x Time Lag 6.3 A, 250 V on L1 and L2	-	-	6.3	A
Over Current	At nominal input voltages V1: Hiccup mode, auto-recovering V2: PTC limiting, auto-recovering 5 V _{SB} : Hiccup mode, auto-recovering	110	-	150	%I _{MAX}
Short Circuit	At nominal input voltages V1: Hiccup mode, auto-recovering V2: PTC limiting, auto-recovering 5 V _{SB} : Hiccup mode, auto-recovering	-	-	-	
Over Voltage	12 V _{DC} 24 V _{DC} 28 V _{DC} 36 V _{DC} 48 V _{DC} 5 V _{SB} Unit shut down and latch off	110	-	136	%V _{NOM}
Over Temperature (on primary stage)	Shut down, latch off	-	-	-	
Over Temperature (on secondary side)	Hiccup mode, auto-recovering	-	-	-	
Isolation Primary-to-Secondary	Reinforced (2x MoPP)	4000	-	-	V _{AC}
Isolation Input-to-PE	Basic (1x MoPP)	1500	-	-	V _{AC}
Isolation V1-to-V2		100	-	-	V _{DC}
Isolation Output-to-PE	Basic (1x MoPP)	1500	-	-	V _{AC}
Touch Current	Normal Condition (NC) Single Fault Condition (SFC)	-	-	100 500	μA

ENVIRONMENTAL SPECIFICATIONS

Specification	Test Conditions / Notes	Min	Nominal	Max	Units
Operating Temperature Range	No de-rating up to 50°C PS starts up at -30 °C	-20	-	50	°C
De-rated Operating Temperature Range	Natural convection cooling: Linearly de-rate from 250W at 50 °C, to 100 W at 70 °C Forced air cooling: Linearly de-rate from 400 W at 50 °C, to 280 W at 70 °C See graphs below	-	-	70	°C
Storage Temperature Range		-40	-	85	°C
Humidity	RH, Non-condensing Operating Non-operating	-	-	90 95	% %
Operating Altitude		-	-	4000	m
Shock	EN 60068-2-27 Operating: Half sine, 30 g, 18 ms, 3 axes, 6x each (3 positive and 3 negative). Non-Operating: Half sine, 50 g, 11 ms, 3 axes, 6x each (3 positive and 3 negative).				
Vibration	EN 60068-2-64 Operating: Sine, 10 – 500 Hz, 1 g, 3 axes, 1 oct/min., 60 min. Random, 5 – 500 Hz, 0.02 g ² /Hz, 1 g _{RMS} , 3 axes, 30 min. Non-Operating: 5 – 500 Hz, 2.46 g _{RMS} (0.0122 g ² /Hz), 3 axes, 30 min.				
MTBF	Full Load, 120 V _{AC} , 40 °C ambient 80% Duty cycle, Telcordia SR-332 Issue 2	400.000	-	-	Hours
Useful Life	Low line range, 200 W, 40 °C ambient, natural convection.	-	4	-	Years
Thermal Considerations	The output power de-rating curves are herein provided. These curves can be used as a guideline to assess the limit in performance of a power supply once installed in a system providing controlled air flow at a certain input voltage and ambient temperature.				

OUTLINE DRAWING AND CONNECTIONS – OPEN FRAME (OF)

Connector	Manufacturer and Part Number
AC Input Connector P1	Molex 26-60-4030 or equivalent
P1 Mating Connector	Molex 09-93-0300 (Crimp Terminal Housing) Molex 08-50-0105 (Crimp Terminal, 18-24 AWG)
Protection Earth Connector P5	Tyco 63849-1 equivalent
P5 Mating Connector	Any tin finished 6.35x0.81 mm receptacle
Output Connector P4	Molex 39-28-8120 or equivalent
P4 Mating Connector	Molex 39-01-2120 (Crimp Terminal Housing) Molex 39-00-0039 (Crimp Terminal, 18-24 AWG)
Signals Connector P6	Molex 90130-1108 or equivalent
P6 Mating Connector	Molex 90142-0008 (Crimp Terminal Housing) Molex 90119-0109 (Crimp Terminal, 22-24 AWG)

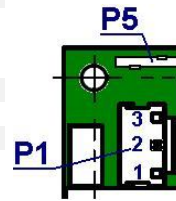

AC Input P1	
Pin	Function
1	Line 1
2	Not Present
3	Line 2

Protection Earth P5	
Pin	Function
1	GND AC Ground

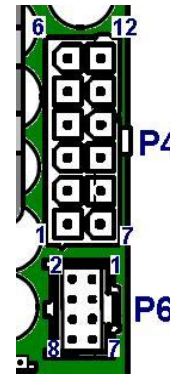

Output Connector P4	
Pin	Function
1-6	V1
7-12	DC Return

Signal Connector P6	
Pin	Function
1	+5V _{SB}
2	P_OK
3	-V2
4	PS_ON
5	RS+
6	RTN
7	+V2
8	RTN

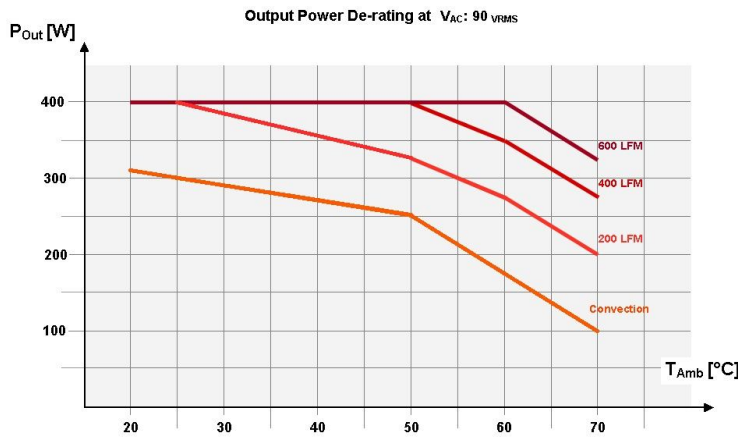

Overall dimensions: 76.0 x 164.2 x 37.7 mm (2.99 x 6.46 x 1.48 in)

Weight: 410 g (0.90 lb)

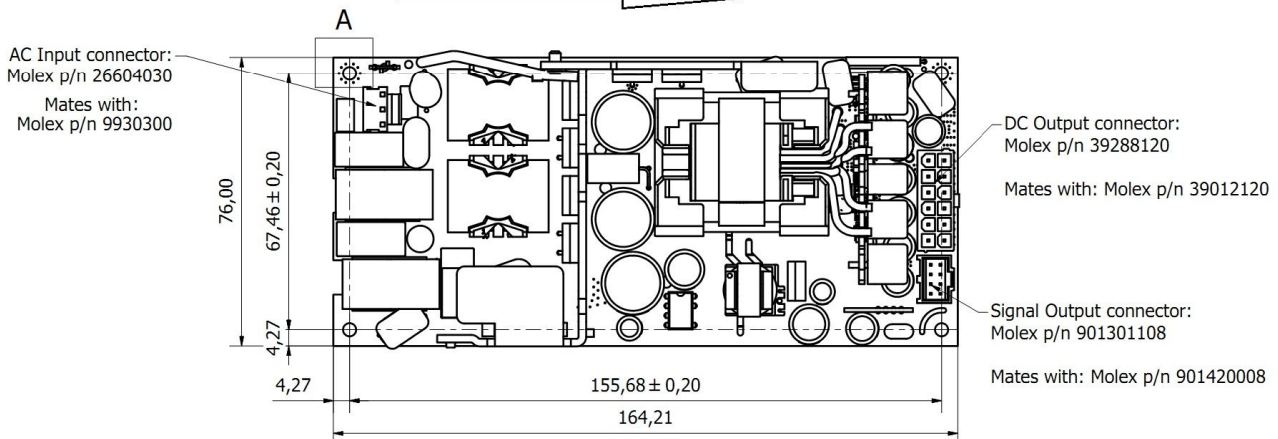
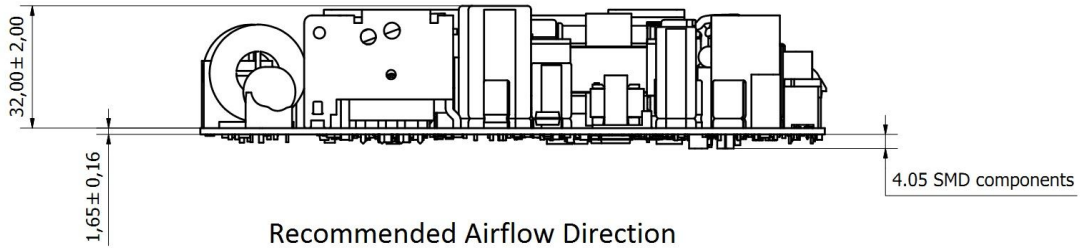

OUTLINE DRAWING AND CONNECTIONS – U-CHASSIS (UC)

Connector	Manufacturer and Part Number
AC Input Connector P1	Molex 26-60-4030 or equivalent
P1 Mating Connector	Molex 09-93-0300 (Crimp Terminal Housing) Molex 08-50-0105 (Crimp Terminal, 18-24 AWG)
Protection Earth Connector P5	Tyco 63849-1 equivalent
P5 Mating Connector	Any tin finished 6.35x0.81 mm receptacle
Output Connector P4	Molex 39-28-8120 or equivalent
P4 Mating Connector	Molex 39-01-2120 (Crimp Terminal Housing) Molex 39-00-0039 (Crimp Terminal, 18-24 AWG)
Signals Connector P6	Molex 90130-1108 or equivalent
P6 Mating Connector	Molex 90142-0008 (Crimp Terminal Housing) Molex 90119-0109 (Crimp Terminal, 22-24 AWG)

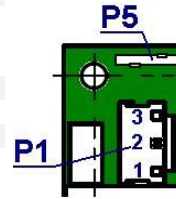

AC Input P1	
Pin	Function
1	Line 1
2	Not Present
3	Line 2

Protection Earth P5	
Pin	Function
GND	AC Ground

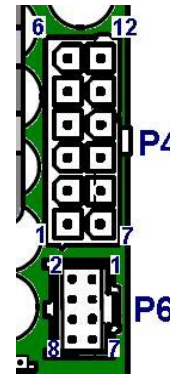

Output Connector P4	
Pin	Function
1-6	V1
7-12	DC Return

Signal Connector P6	
Pin	Function
1	+5V _{SB}
2	P_OK
3	-V2
4	PS_ON
5	RS+
6	RTN
7	+V2
8	RTN

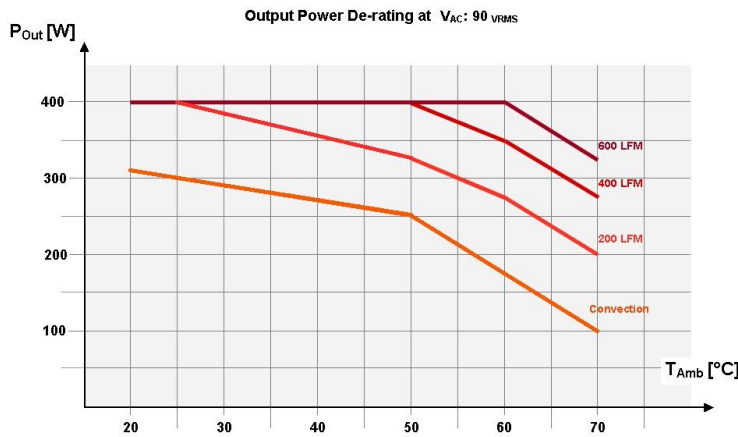

Overall dimensions: 84.4 x 166.5 x 40.0 mm (3.32 x 6.55 x 1.57 in)

Weight: 525 g (1.16 lb)

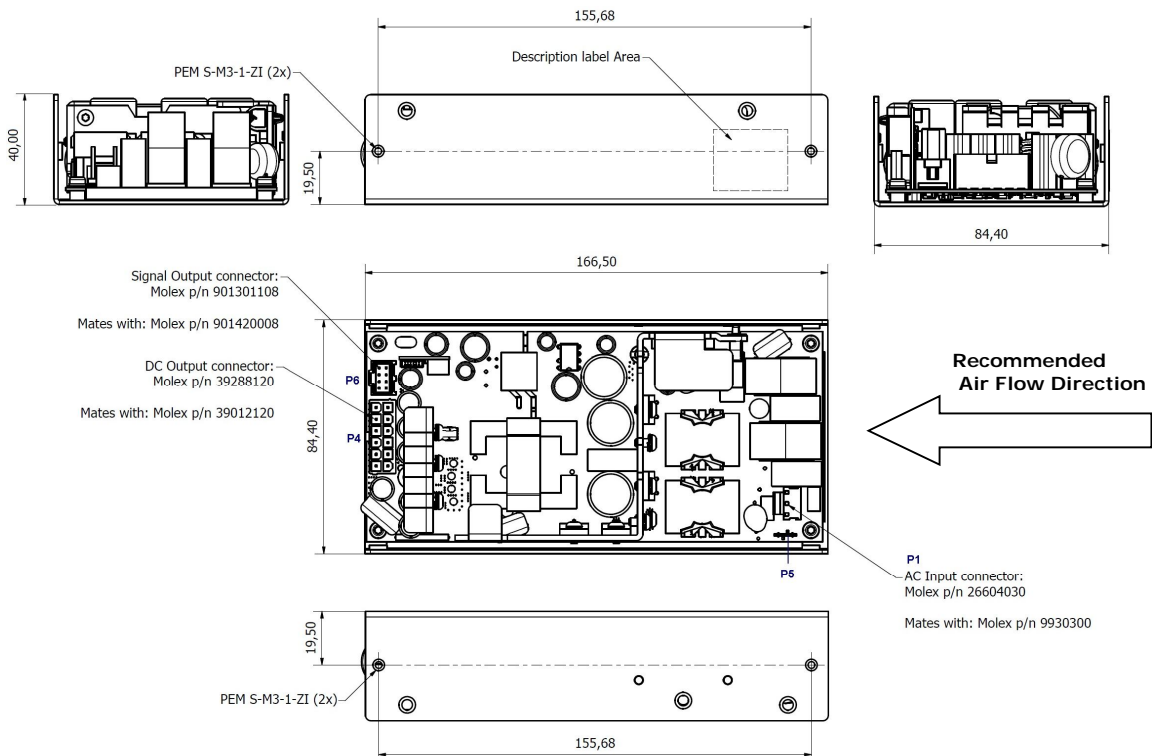

OUTLINE DRAWING AND CONNECTIONS – PUNCHED COVER (PC)

Connector	Manufacturer and Part Number
AC Input Connector P1	Molex 26-60-4030 or equivalent
P1 Mating Connector	Molex 09-93-0300 (Crimp Terminal Housing) Molex 08-50-0105 (Crimp Terminal, 18-24 AWG)
Protection Earth Connector P5	Tyco 63849-1 equivalent
P5 Mating Connector	Any tin finished 6.35x0.81 mm receptacle
Output Connector P4	Molex 39-28-8120 or equivalent
P4 Mating Connector	Molex 39-01-2120 (Crimp Terminal Housing) Molex 39-00-0039 (Crimp Terminal, 18-24 AWG)
Signals Connector P6	Molex 90130-1108 or equivalent
P6 Mating Connector	Molex 90142-0008 (Crimp Terminal Housing) Molex 90119-0109 (Crimp Terminal, 22-24 AWG)

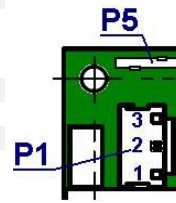

AC Input P1	
Pin	Function
1	Line 1
2	Not Present
3	Line 2

Protection Earth P5	
GND	AC Ground

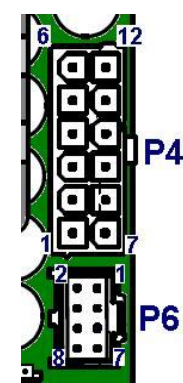

Output Connector P4	
Pin	Function
1-6	V1
7-12	DC Return

Signal Connector P6	
Pin	Function
1	+5V _{SB}
2	P_OK
3	-V2
4	PS_ON
5	RS+
6	RTN
7	+V2
8	RTN

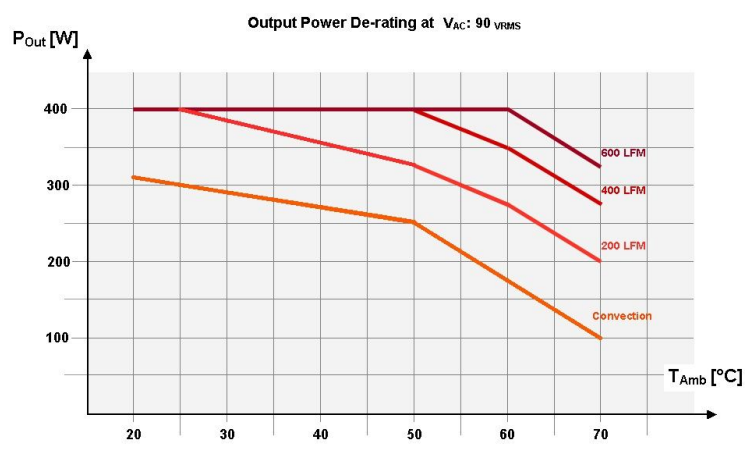

Overall dimensions: 84.4 x 170.5 x 41.0 mm (3.32 x 6.71 x 1.61 in)

Weight: 575 g (1.43 lb)

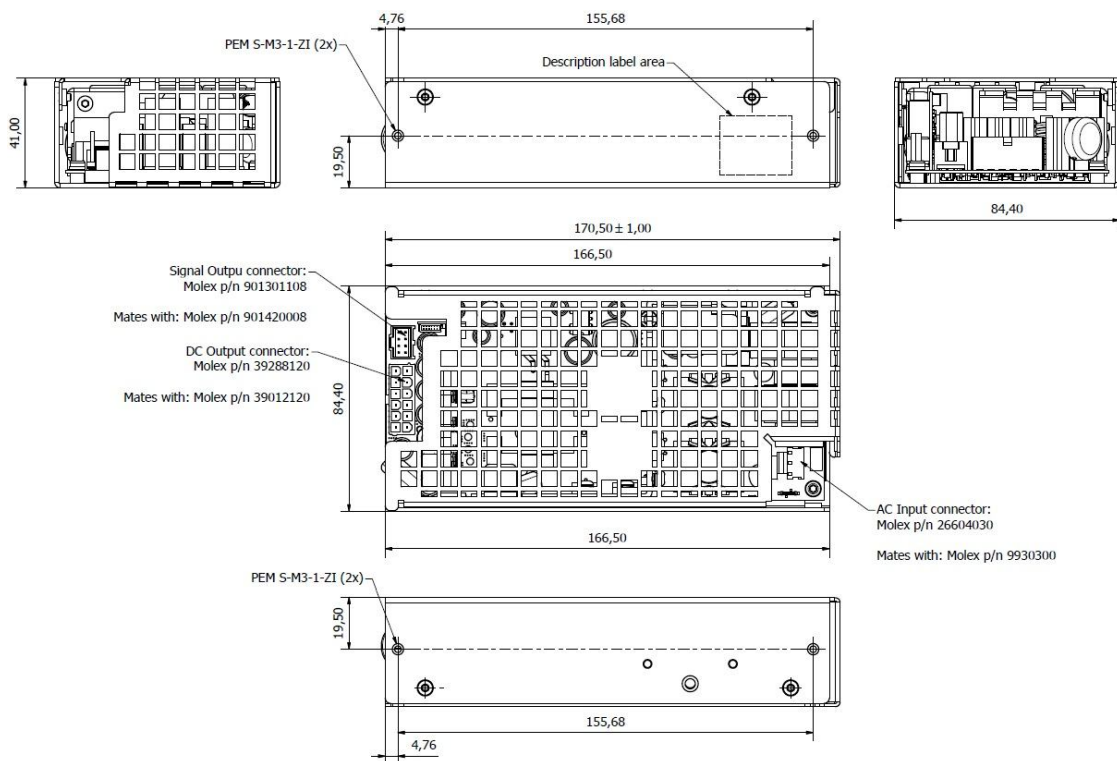

OUTLINE DRAWING AND CONNECTIONS – VENTED COVER (VC)

Connector	Manufacturer and Part Number
AC Input Connector P1	Molex 26-60-4030 or equivalent
P1 Mating Connector	Molex 09-93-0300 (Crimp Terminal Housing) Molex 08-50-0105 (Crimp Terminal, 18-24 AWG)
Protection Earth Connector P5	Tyco 63849-1 equivalent
P5 Mating Connector	Any tin finished 6.35x0.81 mm receptacle
Output Connector P4	Molex 39-28-8120 or equivalent
P4 Mating Connector	Molex 39-01-2120 (Crimp Terminal Housing) Molex 39-00-0039 (Crimp Terminal, 18-24 AWG)
Signals Connector P6	Molex 90130-1108 or equivalent
P6 Mating Connector	Molex 90142-0008 (Crimp Terminal Housing) Molex 90119-0109 (Crimp Terminal, 22-24 AWG)

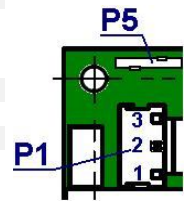

AC Input P1	
Pin	Function
1	Line 1
2	Not Present
3	Line 2

Protection Earth P5	
Pin	Function
GND	AC Ground

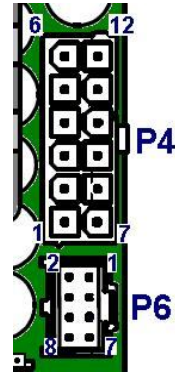

Output Connector P4	
Pin	Function
1-6	V1
7-12	DC Return

Signal Connector P6	
Pin	Function
1	+5V _{SB}
2	P_OK
3	-V2
4	PS_ON
5	RS+
6	RTN
7	+V2
8	RTN

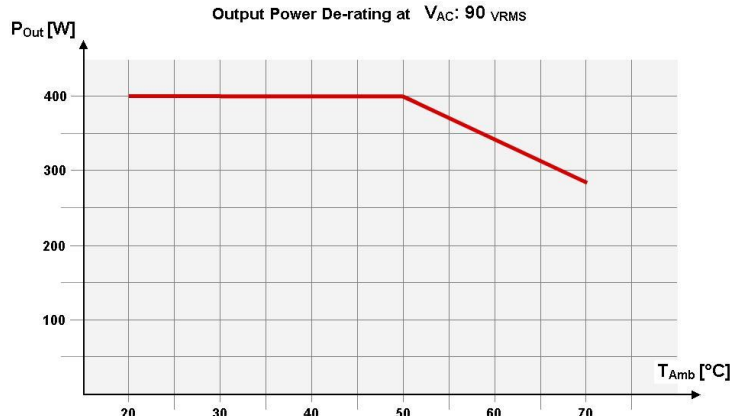

Overall dimensions: 84.4 x 166.5 x 41.0 mm (3.32 x 6.55 x 1.61 in)
Weight: 670 g (1.48 lb)

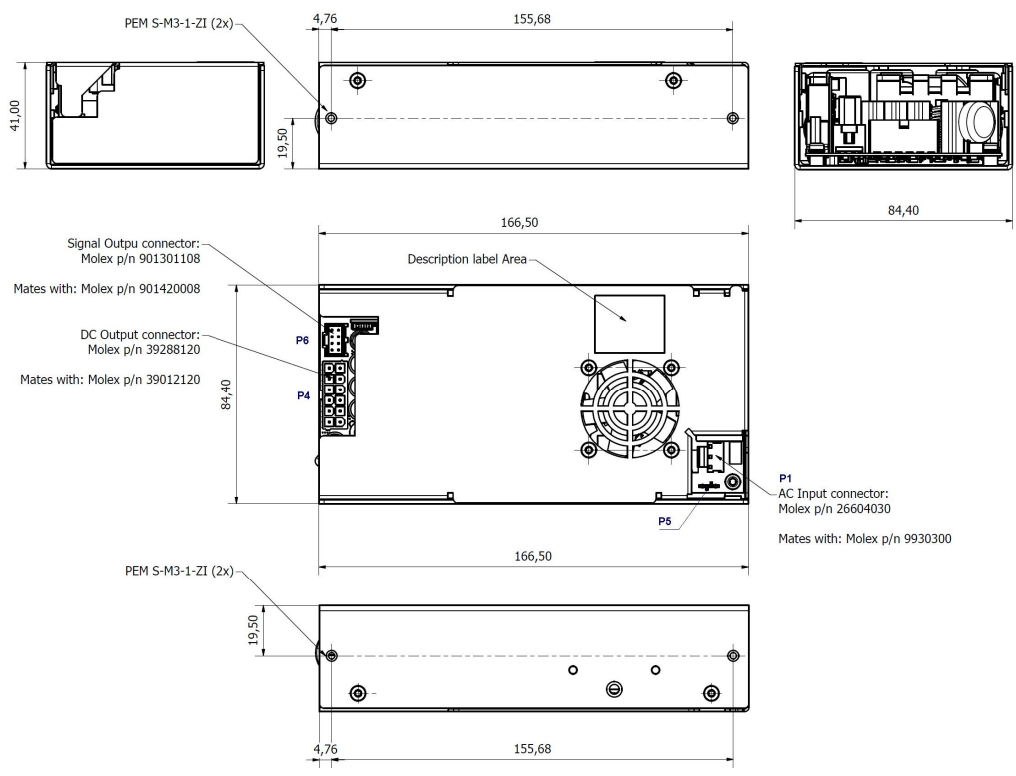

OUTLINE DRAWING AND CONNECTIONS – FRONT FAN (FF)

Connector	Manufacturer and Part Number
AC Input Connector P1	Molex 26-60-4030 or equivalent
P1 Mating Connector	Molex 09-93-0300 (Crimp Terminal Housing) Molex 08-50-0105 (Crimp Terminal, 18-24 AWG)
Protection Earth Connector P5	Tyco 63849-1 equivalent
P5 Mating Connector	Any tin finished 6.35x0.81 mm receptacle
Output Connector P4	Molex 39-28-8120 or equivalent
P4 Mating Connector	Molex 39-01-2120 (Crimp Terminal Housing) Molex 39-00-0039 (Crimp Terminal, 18-24 AWG)
Signals Connector P6	Molex 90130-1108 or equivalent
P6 Mating Connector	Molex 90142-0008 (Crimp Terminal Housing) Molex 90119-0109 (Crimp Terminal, 22-24 AWG)

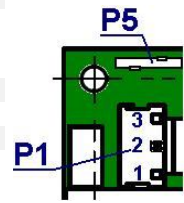

AC Input P1	
Pin	Function
1	Line 1
2	Not Present
3	Line 2

Protection Heart P5	
Pin	Function
1	GND
2	AC Ground

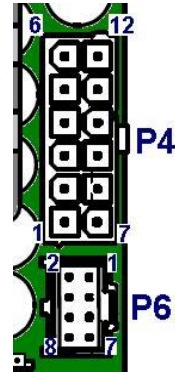

Output Connector P4	
Pin	Function
1-6	V1
7-12	DC Return

Signal Connector P6	
Pin	Function
1	+5V _{SB}
2	P_OK
3	-V2
4	PS_ON
5	RS+
6	RTN
7	+V2
8	RTN

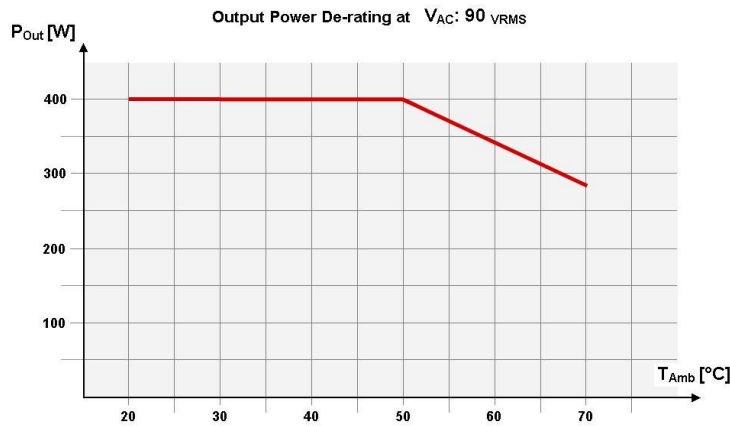

Overall dimensions: 84.4 x 183.0 x 41.0 mm (3.32 x 7.20 x 1.61 in)

Weight: 685 g (1.51 lb)

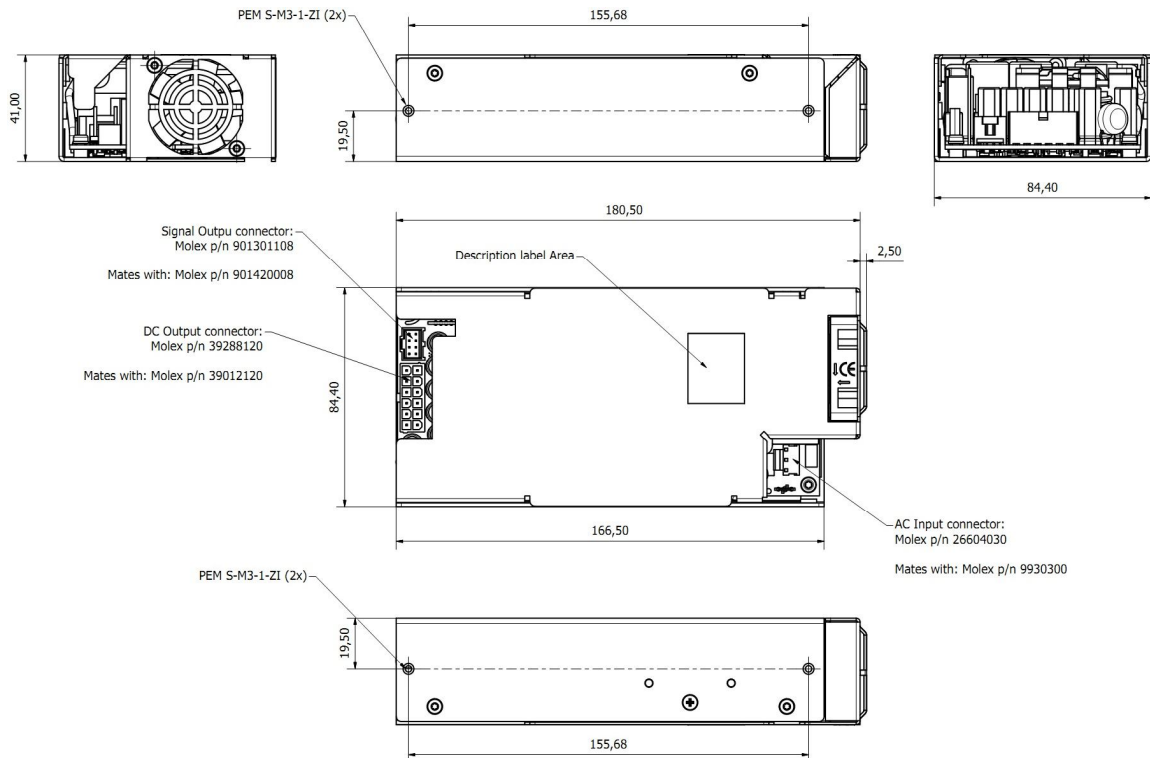

ELECTROMAGNETIC COMPATIBILITY (EMC) – EMISSIONS

Phenomenon	Conditions / Notes	Standard	Equipment Performance Class
Conducted	115 V _{RMS} , 230 V _{RMS} . Maximum load. 4 dB minimum margin	EN 60601-1-2 (Medical)	B
Radiated	At 10 m distance, VC and FF package variants	EN 60601-1-2 (Medical)	B
Line Voltage Fluctuation and Flicker	At 20%, 50% and 100% maximum load. Nominal input voltages.	EN 61000-3-3	
Harmonic Current Emission	Nominal input voltages. Output load > 50 W.	EN 61000-3-2	C

ELECTROMAGNETIC COMPATIBILITY (EMC) – IMMUNITY

Phenomenon	Conditions / Notes	Standard	Test Level	Performance criteria
	Reference standard for the medical version	EN 60601-1-2 4th edition		
ESD	15 kV air discharge, 8 kV contact, at any point of the system.	EN 61000-4-2	4	A
Radiated Field	3 V/m, 80-1000 MHz, 1 KHz/2 Hz 80% AM. Dwell time is 3 sec for 2 Hz modulation Dwell time is 1 sec for 1KHz modulation	EN 61000-4-3	3	A
Electric Fast Transient	±2 kV on AC power port for 1 minute; ±1 kV on signal/control lines	EN 61000-4-4	3	A
Surge	± 2 kV line to line; ± 4 kV line to earth; on AC power port.	EN 61000-4-5	3	A B
Conducted RF Immunity	3 V _{RMS} , 0,15-80 MHz, 1 KHz/2 Hz 80% AM	EN 61000-4-6	3	A
Dips and Interruptions	Dip to 30% for 0.5 cycle (10 ms)	EN61000-4-11		A
	Dip to 40% for 5 cycles (100 ms)	EN61000-4-11		B
	Dip to 70% for 25 cycles (500 ms)	EN61000-4-11		B
	Drop-out to 5% for 10 ms	EN61000-4-11		B
	Interrupts > 95% for 5 s	EN61000-4-11		B

SAFETY AGENCIES APPROVALS

Certification Body	Safety Standards	Category
CSA/UL	CSA C22.2 No.60601-1, ANSI/AAMI ES60601-1 3 rd Edition + A1	Medical
IEC IECEE	IEC/EN 60601-1 3 rd edition+A1	Medical
CB Certification		
CE	Directive 93/42/CEE: Safety Requirement of the Medical Device	Medical
	Directive 2014/30/EU: Electromagnetic Compatibility (EMC)	
	Directive EU 2015/863 (RoHS 3)	
Designed to meet IEC/EN/UL/CSA 61010-1 2 nd edition		

Specifications appearing in ENEDO's catalogues and brochures as well as any oral statements are not binding. All descriptions, drawings and other particulars (including dimensions, materials and performance data) given by ENEDO are as accurate as possible but, being given for general information, and are not binding on ENEDO. ENEDO makes thus no representation or warranty as to the accuracy of such material. We assume no liability other than as agreed in the terms of the individual contracts and we reserve the right to make technical modifications in the course of our product development. Our product information solely describes our goods and services and is in no way to be construed or interpreted as a quality or condition guarantee. The aforesaid shall not relieve the customer of its obligation to verify the suitability of our Products for the use or application intended by the purchaser. Customers are responsible for their products and applications. ENEDO assumes no liability from the use of its products outside of specifications. No license is granted to any intellectual property rights by this document